

Resistance thermometers WTh 25

Part no. 32244

Resistance thermometers

benefits

- suitable for use in mechanical engineering, plant engineering, appliance engineering, process engineering and chemical industry
- screw-in resistance thermometer with Pt100 sensor
- Wetted parts 316 Ti

Application

Screw-in resistance thermometer for medium pressure and flow loads at higher temperatures

Technical Specifications

Sensor

1 x
3-wire
Class B, IEC 751

Measuring insert

replaceable
Diameter: 6 mm

Thermowell

As per DIN 43772
Ø 9 x 1 mm
Stainless steel 316 Ti

Neck

Ø 9 x 1 mm
Length: 120 mm
Stainless steel 316 Ti

Process connection

G $\frac{1}{2}$ B
Stainless steel 316 Ti

Installation length

400 mm

Connection head

Type B As per DIN 43729
aluminium die cast

Electrical connection

Cable gland

Degree of protection

IP 54 (EN 60529)

Measuring range

-35/+400 °C

Options

- Sensor class A

- sensor Pt1000
- reduced measuring tip (6 mm)
- Transmitter installation
- other thermowell materials
- other process connections
- other installation lengths

Technical Drawings

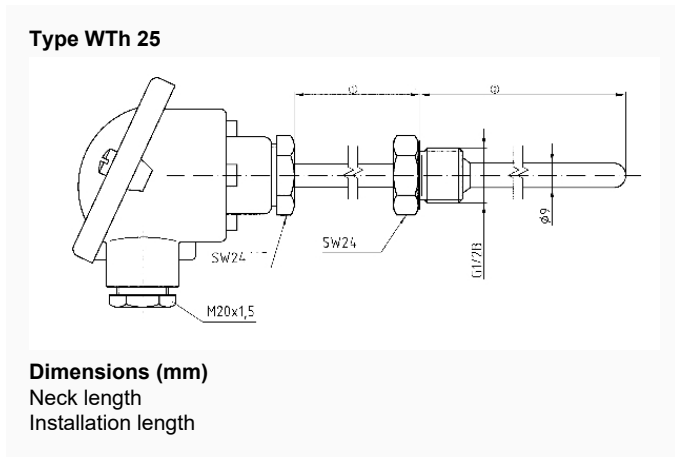

Versions

	Installation length	Part no.
Resistance thermometers WTh 25	400 mm	32244

- in-stock items
- Non-stock items