

Resistance thermometers WTh 30

Part no. 32307

Resistance thermometers

benefits

- hygienic design as per EHEDG recommendations
- compact design
- high accuracy
- short response time
- various process connections
- transducer can be integrated

Application

For temperature measurement in tanks and pipelines and applications requiring hygienic process connections, materials and processing. Specially suitable for food, pharmaceutical and biotechnology applications due to the compact design and the high accuracy.

Description

WTh 30 consists of a sturdy stainless steel housing with diverse process connections and a Pt 100 measuring insert which is directly integrated in a thermowell. The change in resistance depending on the measured temperature is directly available as a signal or can be detected by a transducer and converted into a 4–20 mA output signal. The instrument is connected by means of a compact M12 plug connection.

Technical Specifications

Sensor

1 x
4-wire
class A, IEC 751

Thermowell

Ø 6 mm
Stainless steel 316 L

Process connection

G½B
Stainless steel 316 L

Installation length

200 mm

Electrical connection

connector M12
Connector housing: Stainless steel

Housing

material: Stainless steel
Diameter: 18 mm

Degree of protection

IP 67 (EN 60529)

Surface roughness

R_a : < 0.8 μm

welding seam: < 1.6 μm

Operating pressure

max. 16 bar

Options

- integrated transducer
- other process connections
- Electropolishing
- replaceable measuring insert
- other installation lengths
- weld-in sockets

Measuring range

-50/+200 °C

response time t_{90}

5.5 s as per EN 60751, test in flowing water (without transducer)

Technical Drawings

Weld-in socket

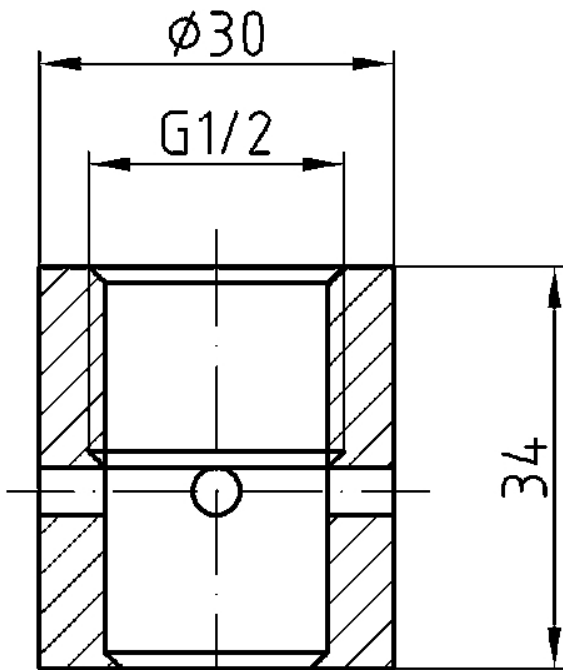

①

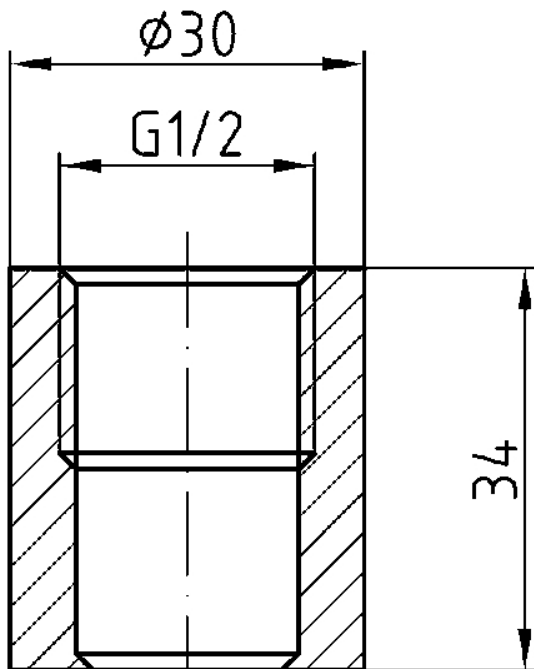

②

Dimensions (mm)
Socket with inspection hole

Versions

		Installation length		Part no.
	Resistance thermometers WTh 30	200 mm	●	32307

- in-stock items
- Non-stock items