



Pressure transducers DMU 04

Part no. 31685

Pressure transducers DMU 04 Industrial version

benefits

- DMU 04 CP/MR for hygienic processes
- small temperature error
- Options: Ex, field housing or high temperature version (up to 300 °C) and SIL 2

Application

For applications requiring hygienic process connections, materials or processing, especially food technology, pharmaceutical and biotechnology applications.

Description

Pressure transducers convert physical pressure into an electrical signal proportional to the pressure. DMU 4 is equipped with an oil-filled piezo-resistive silicon measuring cell. DMU 04 has safety integrity level SIL 2 (IEC 61508/61511).

Technical Specifications

Measuring accuracy

Deviation from the characteristic curve according to IEC 60770 – limit point calibration (non-linearity, hysteresis, repeatability)

> 0/40 bar < ± 0.5 % FSO

Measuring range

0/400 bar

Overpressure safety

at least 3 x FS

Burst pressure

at least 5 x FS

Operating temperature range

Medium: -10/+125 °C

Medium: short-term (60 min) up to 150 °C

Ambient: -40/+85 °C

Storage: -40/+100 °C

Temperature error band

≥ 400 mbar

$\leq \pm 0.75$ % FSO/10 K In compensated range -20/+85 °C

dynamic characteristics

Response time: ≤ 10 ms

Process connection

G1B DIN 3852 type E with flush diaphragm

material

Housing: Stainless steel 316 L
pressure connection: Stainless steel 316 L
diaphragm: Stainless steel 316 L

pressure transmission liquid

Food oil, FDA-compliant

Supply voltage

DC 8 – 32 V

Output signal

2-wire, 4–20 mA

Load

$R_{\max} = [(UB - UB_{\min})/0.02 \text{ A}] \Omega$

Current input

< 25 mA

electrical protection

short circuit proof and protected against reverse polarity

Electrical connection

Connector and junction box as per ISO 4400 (DIN 43650-A)

Degree of protection

IP 65 (EN 60529)

CE conformity

EMC Directive 2014/30/EU

RoHS Directive 2011/65/EU

Pressure Equipment Directive 2014/68/EU

Options

- other process connections
- other electrical connections
- Field housing (stainless steel 303)
- High temperature version up to 300 °C
- higher accuracy
- Union nut DN 25/40/50
- EX version (II 1G Ex ia IIC T4 Ga, II 1D Ex ia IIIC T85°C Da)
- SIL 2 (IEC 61508/61511) 2-wire

Technical Drawings

**DMU 04 - connection G $\frac{1}{2}$ B
with flush diaphragm**

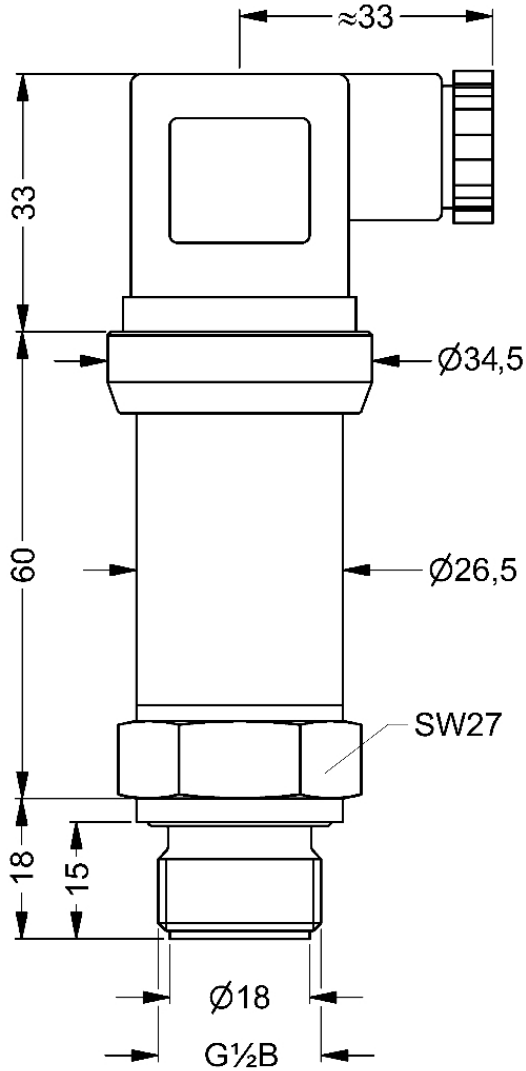

Dimensions (mm)

Versions

Range	Measuring range	Type	Version	Part no.
	0/400 bar	DMU 04	●	31685

- in-stock items
- Non-stock items