



Bourdon tube pressure gauge RF100 rad

Part no. 63609

Bourdon tube pressure gauge RF for heating/plumbing

benefits

- with self-sealing connection thread (NG 50 and 63) for fast mounting
- corrosion-resistant housing

Application

For gaseous and liquid media which are not highly viscous, do not crystallise and do not attack copper alloys and EPDM.
! For measuring gas or vapour, observe the table "Selection Criteria as per EN 837-2" (see appendix)!

Technical Specifications

Nominal size

100

accuracy class (EN 837-1/6)

2.5

ranges

0/1 bar

application area

static load: $\frac{3}{4}$ x full scale value
dynamic load: $\frac{2}{3}$ x full scale value
short-term: Full scale value

Operating temperature range

Medium: max. 60 °C
Ambient: -20/+60 °C

Temperature performance

Indication error when the temperature of the measuring system deviates from the normal temperature of 20 °C:
at rising temperature approx. ± 0.4 %/10 K
falling temperature approx. ± 0.4 %/10 K
of full scale value

Degree of protection

IP 32 (EN 60529)

Connection

Brass, bottom
NG 100
G $\frac{1}{2}$ B

Measuring element

Bourdon tube, "C" type tube
Copper alloy

movement

Brass

Dial
Plastic, white
Scaling: black

Pointer
Plastic, black

Housing
Plastic (ABS), black, highly impact-resistant and corrosion-resistant

window
Plastic, clipped in
NG 100
with adjustable red reference pointer

Technical Drawings

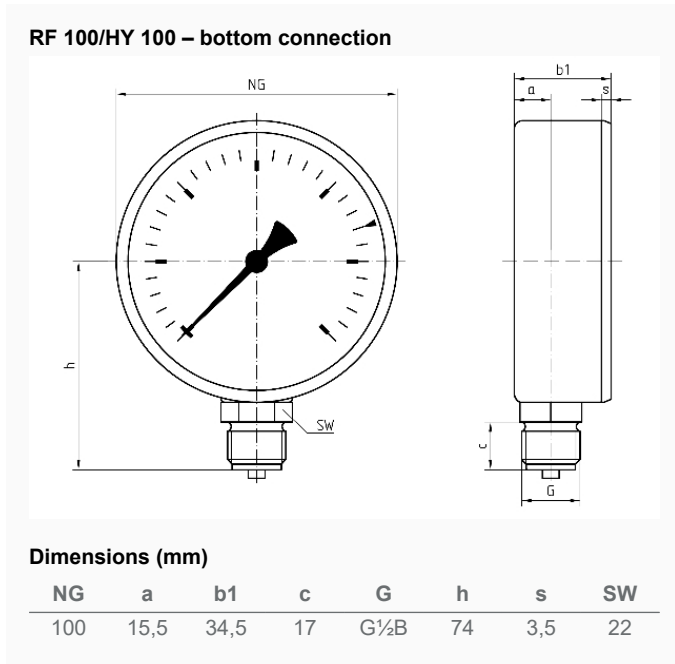

Versions

	housing ø	Conne- tion	Conne- tion	Thread	alignment	Range	Type	Part no.
RF100	100 mm	G½B			bottom	0/1 bar	RF100 rad	63609

- in-stock items
- Non-stock items