



## Standard capsule pressure gauges KP63

Part no. 35023451

Standard capsule pressure gauges Type D4

### benefits

- with zero correction
- optional overpressure and/or underpressure safety 10 x FSD
- extremely low measuring ranges from 0/6 mbar
- GOSSTANDART-certified

### Application

For gaseous, dry media which do not attack copper alloys.

! For measuring gas or vapour, observe the table "Selection Criteria as per EN 837-2" (see appendix)!

### Technical Specifications

#### Type

D4

#### Nominal size

63

#### accuracy class (EN 837-3/6)

1.6

#### ranges (EN 837-3/5)

see ordering table

#### application area

static load: Full scale value  
dynamic load: 0.9 x full scale value  
overload safety: 1.3 x full scale value

#### Operating temperature range

Medium: max. 60 °C  
Ambient: -20/+60 °C

#### Temperature performance

Indication error when the temperature of the measuring system deviates from the normal temperature of 20 °C:  
at rising temperature approx.  $\pm 0.6 \%$ /10 K  
falling temperature approx.  $\pm 0.6 \%$ /10 K  
of full scale value

#### Degree of protection

NG 63  
IP 33 (EN 60529)

#### Connection

Brass, centre back

#### Measuring element

Capsule element, CuBe alloy

#### movement

Brass

#### Zero correction

from the front

**Seal**  
NBR (Perbunan)

**Dial**  
Aluminium, white  
Scaling: black

**Pointer**  
Aluminium, black

**Housing**  
Stainless steel 304

**bayonet bezel**  
Stainless steel 304

**window**  
D451  
Plastic (PMMA)

**Options**

- overpressure and underpressure safety 10 x FSD
- back flange
- Panel mounting bezel, with window, plastic
- 3-hole fixing, panel mounting bezel with window, plastic
- throttle screw
- Reference pointer
- special scales
- other process connections

**Technical Drawings**

**Centre back connection, panel mounting bezel with clamp fixing**

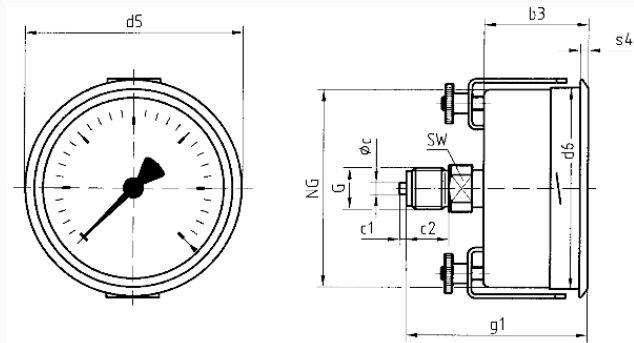

**Dimensions (mm)**

NG	b3	∅c	c1	c2	d5	d6	G	g1	s4	SW
63	37	5	2	13	68	64	G¼B	60	3	14
100	49	6	3	20	107	101	G½B	81	4	22
160	52	6	3	20	167	161	G½B	84	4,5	22

## Versions

Range	Mounting type	Type	Part number
0/600 mbar	Panel mounting bezel, with clamp fixing	KP63 D451	35023451

- in-stock items
- Non-stock items